

no label

INTERIEUR & ONTWERP

banken no label



onze banken collectie



nolabel#8

Dit gedurfde en eigentijdse modulaire banksysteem eert flexibiliteit met een ontwerp geïnspireerd op stedelijke architectuurideeën van moderne informele woonruimtes.



nolabel#6

Upgrade uw lounge-ervaring met deze elegante en comfortabele bank. Clyde kan elke ruimte gezelliger maken. her



nolabel#10

Eenvoud en comfort zijn slechts twee van de vele voordelen .



nolabel#12

De modulaire bank combineert comfort en stijl en biedt u eindeloze manieren om uw ruimte te personaliseren.



nolabel#7

Als u een duidelijke identiteit en karakter aan uw kamer wilt toevoegen, zoek dan niet verder



nolabel#11

Gedurfd, zelfverzekerd en comfortabele

nolabel#8

n

nolabel

INTERIEUR & ONTWERP



nolabel#8



fabric



STD standard



LUX lux

COVERS



LCV loose with velcro

SPECIAL



modular system



All elements are freestanding.

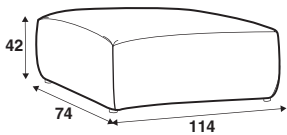

footstool 114x74

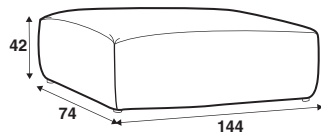

footstool 144x74

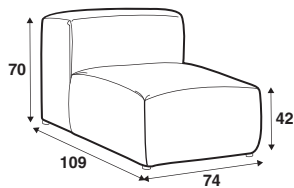

element 74x109

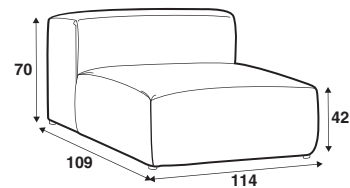

element 114x109

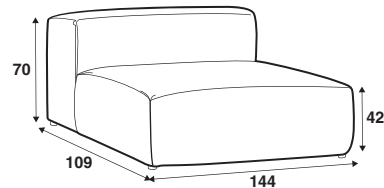

element 144x109

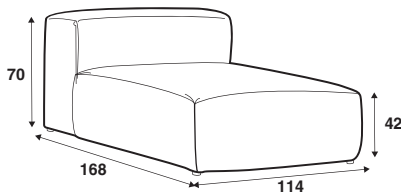

element 114x168

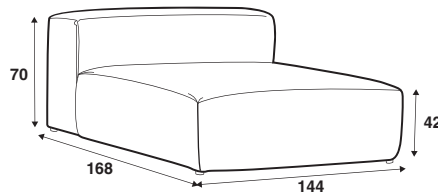

element 144x168

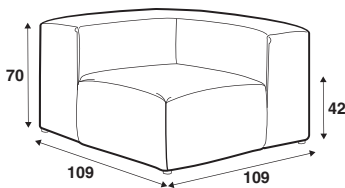

corner 90°

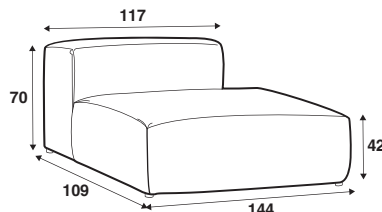

bench 144x109 right / or left

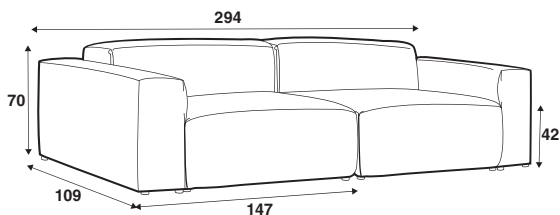

set1

2x element 114x109 + 2x armrest 109x33

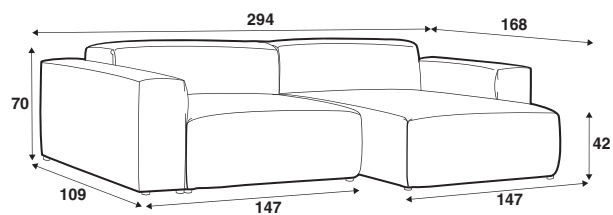

set2

element 114x109 + element 114x168 + 2x armrest 109x33

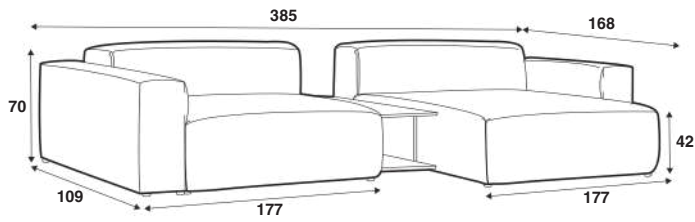

set 3

element 144x109 + element 144x168
 + 2x armrest 109x33 + coffee table 104x31

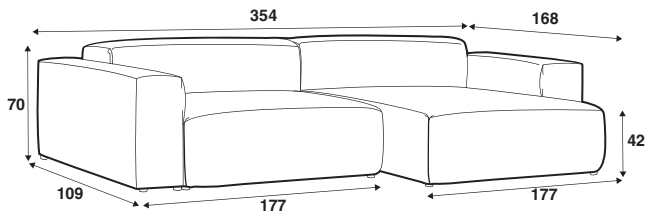

set 4

element 144x109 + element 144x168 + 2x armrest 109x33

extra dimensions

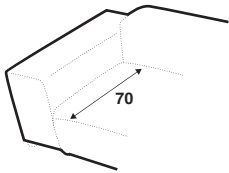

depth of seat

accessories

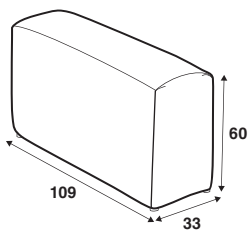

armrest 109x33

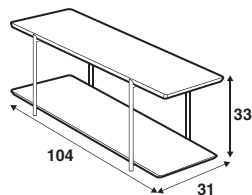

coffee table 104x31

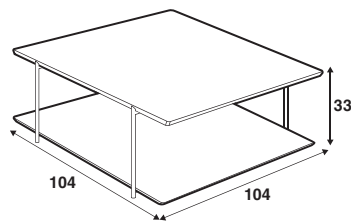

coffee table 104x104

legs

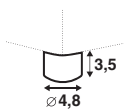

no. 173
 wood

available materials for top



wood: oak



wood: black



wood: walnut

available materials for frame



metal: black

n



profile

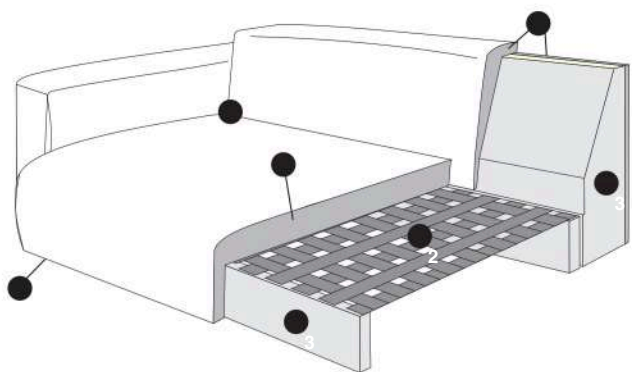

standard

1. polyurethane foam/high resilient polyurethane foam
2. upholstery belts
3. solid wood and wood based elements
4. fabric
5. solid wood or metal legs

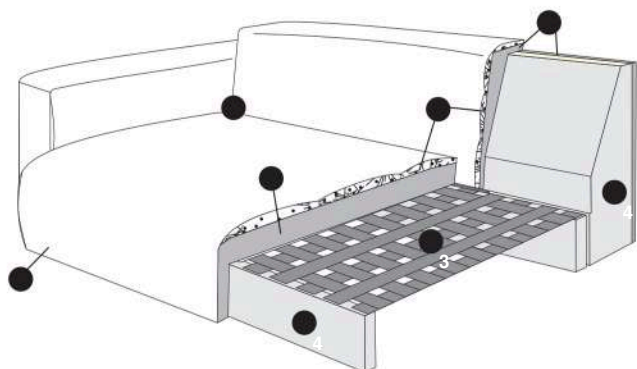

lux

1. polyurethane foam/high resilient polyurethane foam
2. cushion chamber with mix of feather and silicone balls
3. upholstery belts
4. solid wood and wood based elements
5. fabric
6. solid wood or metal legs



nolabel #6 ~~no~~label

INTERIEUR & ONTWERP



nolabel#6

UPHOLSTERY COMFORTCOVERS

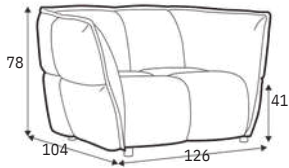

armchair

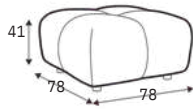

footstool 78x78

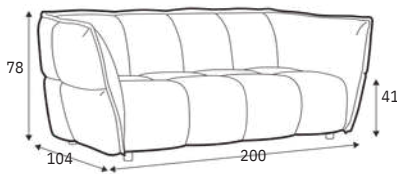

2 seater

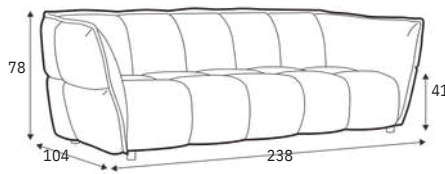

3 seater

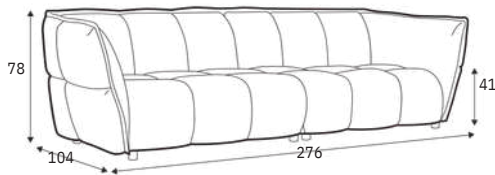

4 seater divided

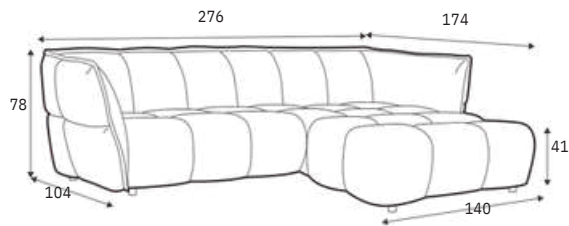

set 1 right / or left

element138left/orright+chaiselongue right / or left

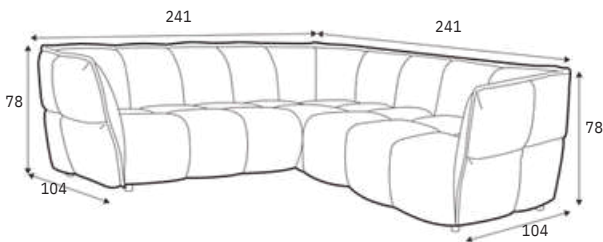

set 2

element138 left / or right + corner 90°

+element 138 right / or left

nolabel#10

~~no~~label

INTERIEUR & ONTWERP



nolabel#10

COVERS

SPECIAL



fabric



STD standard



FC fixed



modular system



All elements available also as freestanding elements.

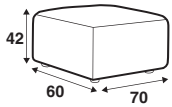

footstool 70x60

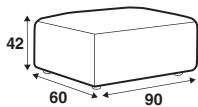

footstool 90x60

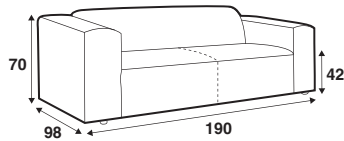

2 seater

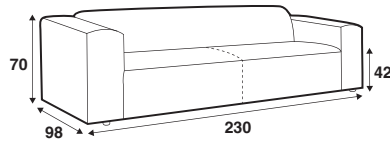

3 seater

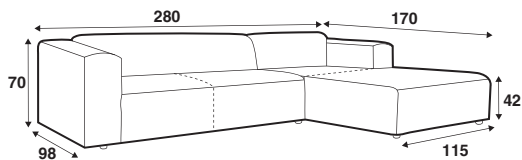

set 1 right / or left

2seaterleft / orright+chaiselongue 115x170 right / or left

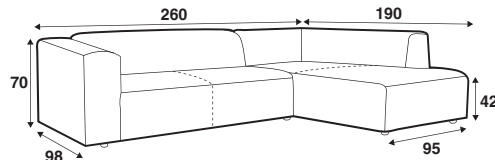

set 2 right / or left

2seaterleft / orright+divan right / or left

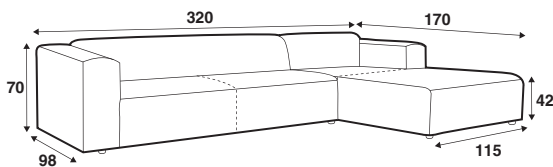

set 3 right / or left

3seaterleft / orright+chaiselongue 115x170 right / or left

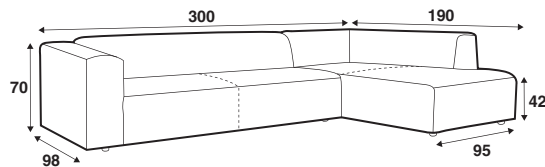

set 4 right / or left

3seaterleft / orright+divan right / or left

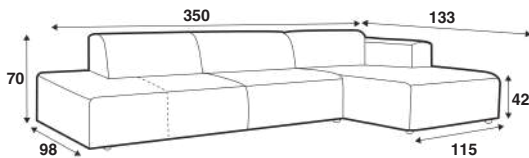

set 5 right / or right

benchleft / or right+element 90 without armrests
+ chaiselongue 115x133 right / or left

modular system

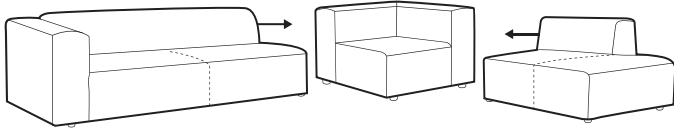

elements of the modular system

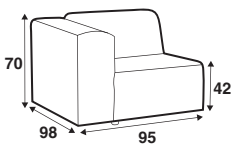

**element 70
left / or right**

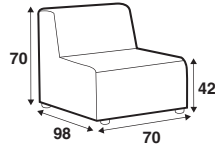

**element 70
without armrests**

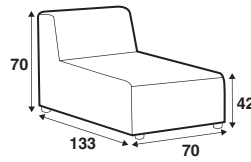

**element
70x133 without
armrests**

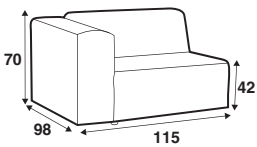

**element 90
left / or right**

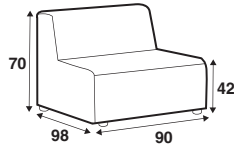

**element 90
without armrests**

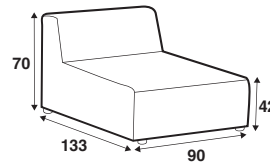

**element
90x133 without
armrests**

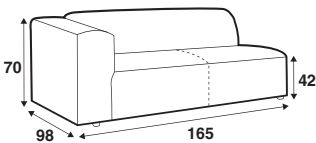

2 seater left / or right

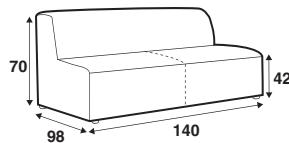

2 seater without armrests

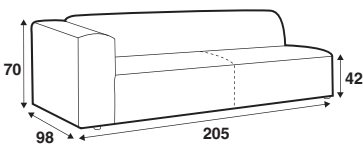

3 seater left / or right

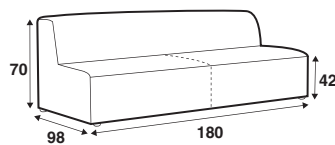

3 seater without armrests

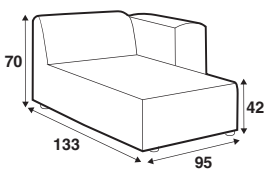

**chaiselongue 95x133
right / or left**

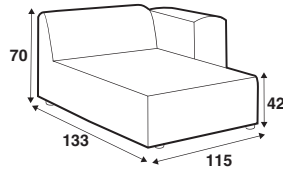

**chaiselongue 115x133
right / or left**

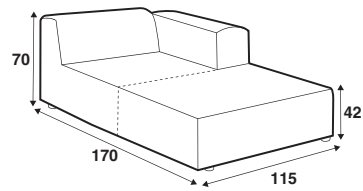

**chaiselongue 115x170
right / or left**

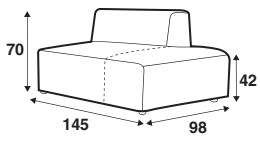

bench right / or left

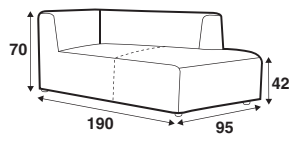

divan right / or left

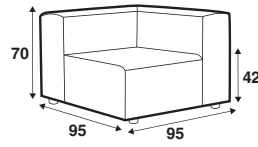

corner 90°

extra dimensions

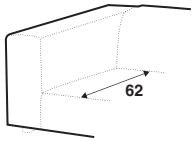

depth of seat

accessories

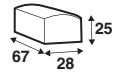
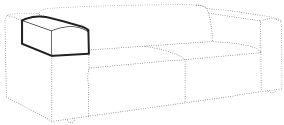

armrest protection

legs

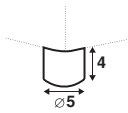

no. 37C
plastic

profile

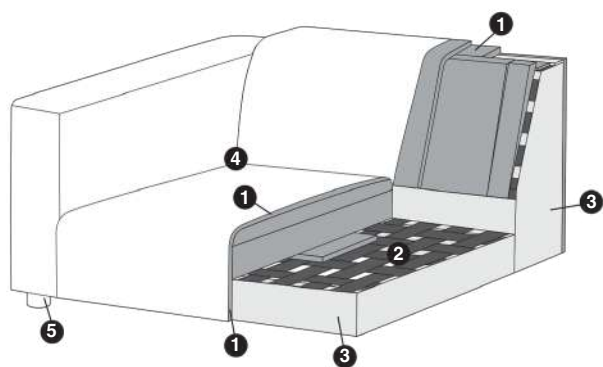

standard

1. polyurethane foam/high resilient polyurethane foam
2. upholstery belts
3. solid wood and wood based elements
4. fabric
5. solid wood/metal legs

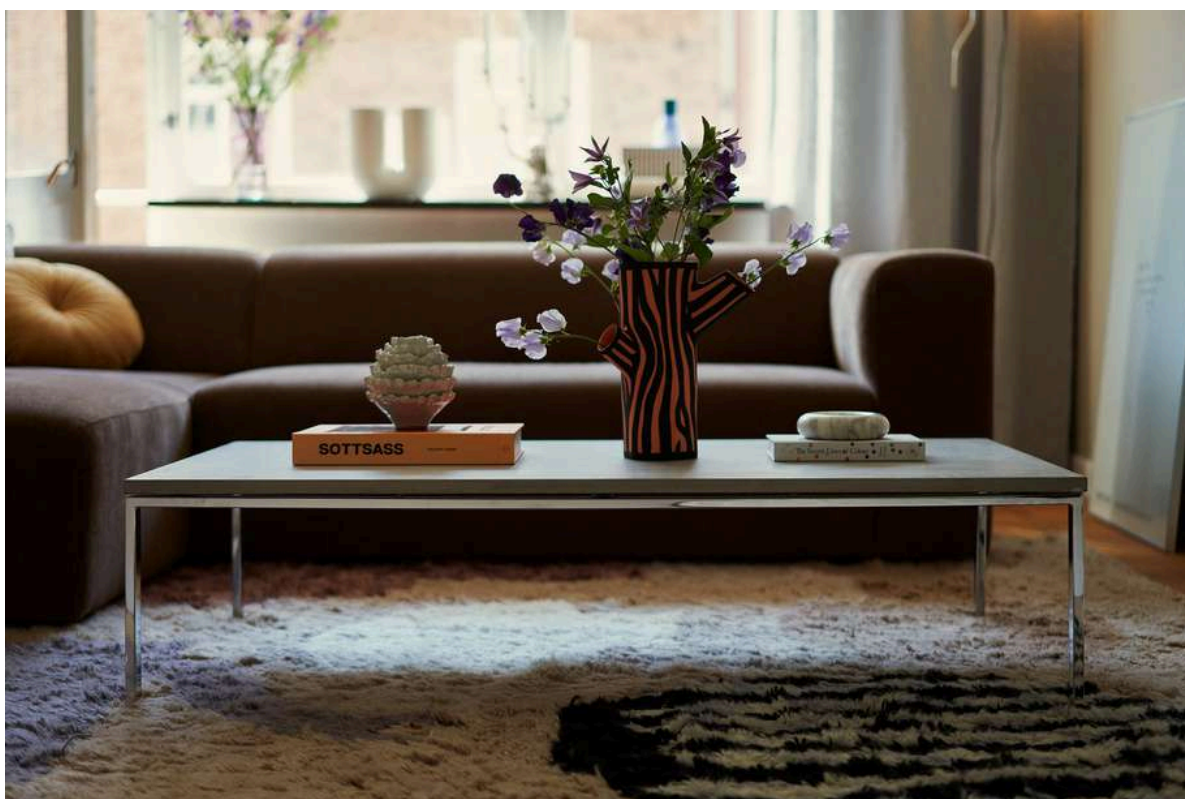

nolabel#12

~~no~~label

INTERIEUR & ONTWERP



nolabel#12

UPHOLSTERY



fabric

COMFORTS



STD standard



LUX lux

COVERS



FC fixed



LCV loose with velcro

SPECIAL



modular system



Drawing show combinations with armrest I.

Combinantons with other armrest are properly longer in width.

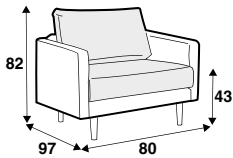

armchair

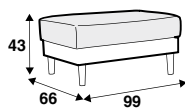

footstool 99x66

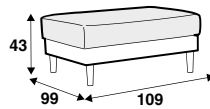

footstool 109x99

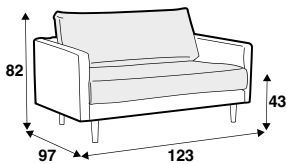

1,5 seater

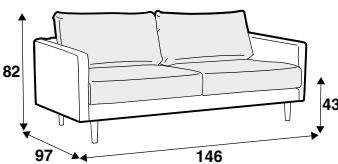

2 seater

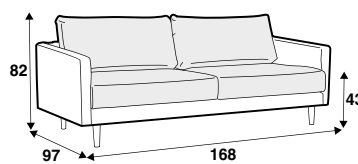

2,5 seater

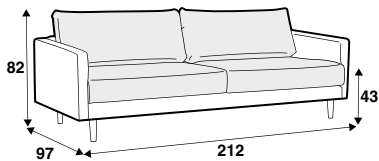

3 seater two cushions

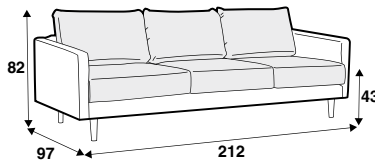

3 seater three cushions

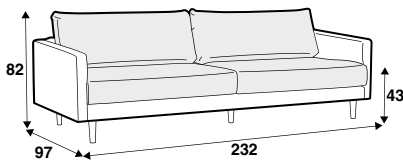

3xl seater two cushions

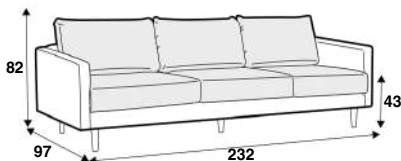

3xl seater three cushions

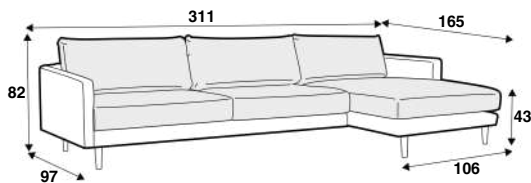

set 1 right / or left

3 seatertwocushions left / or right
+ chaiselongue right / or left

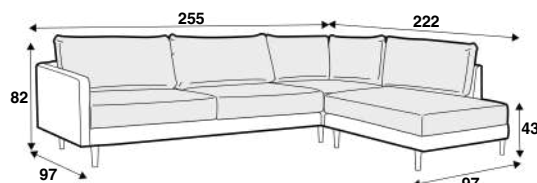

set 2 right / or left

2,5seaterleft / orright+ divan right / or left

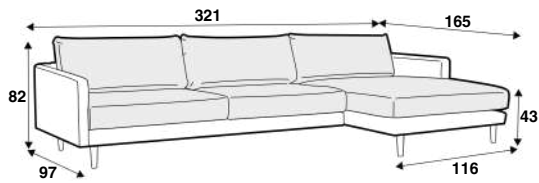

set 3 right / or left
 3 seatertwo cushions left / or right
 + chaiselongue wide right / or left

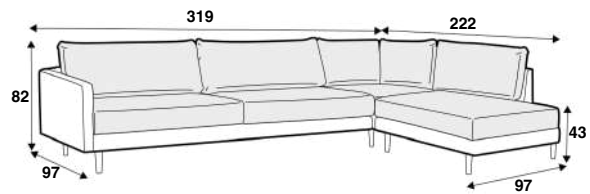

set 4 right / or left
 3xl seatertwo cushionsleft / or right
 + divan right / or left

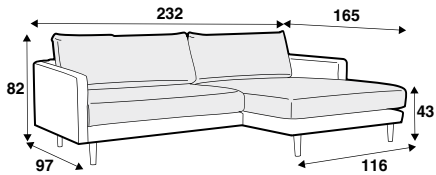

set 5 right / or left
 1,5seaterleft / orright+ chaiselongue wide right / or left

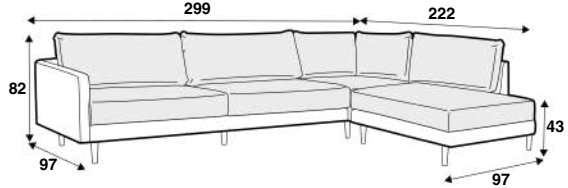

set 6 right / or left
 3seatertwo cushionsleft / or right + divan right / or left

modular system

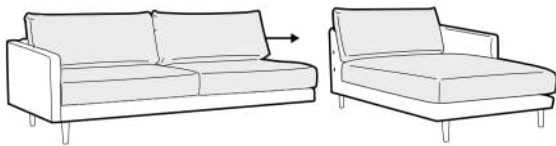

elements of the modular system

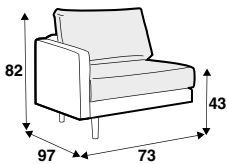

armchair left / or right

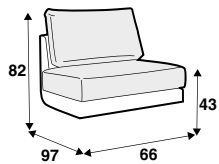

armchair without armrests

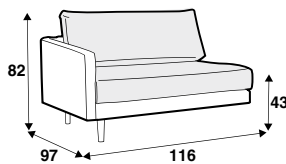

1,5 seater left / or right

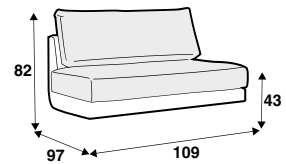

1,5 seater without armrests

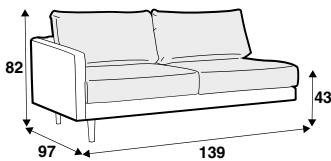

2 seater left / or right

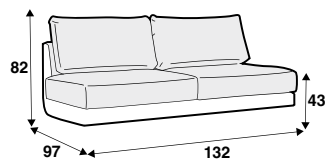

2 seater without armrests

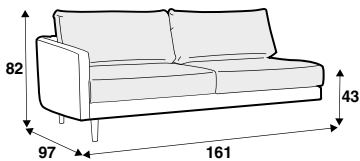

2,5 seater left / or right

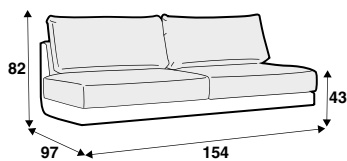

2,5 seater without armrests

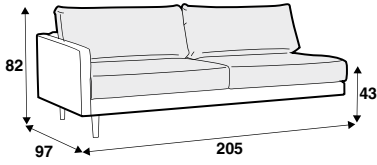

3 seater two cushions left / or right

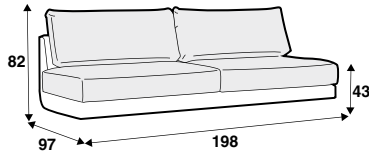

3 seater two cushions without armrests

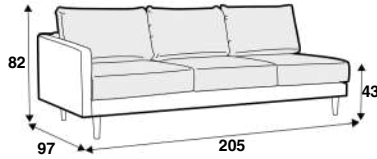

3 seater three cushions left / or right

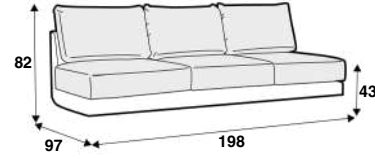

3 seater three cushions without armrests

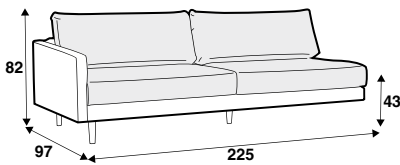

3xl seater two cushions left / or right

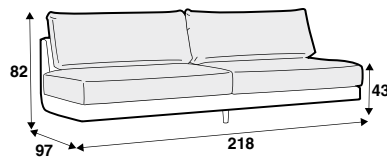

3xl seater two cushions without armrests

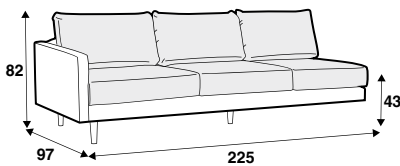

3xl seater three cushions left / or right

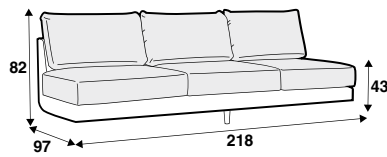

3xl seater three cushions without armrests

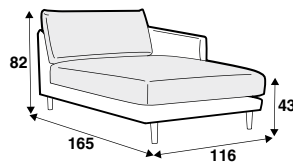
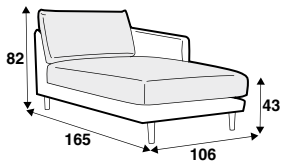

chaiselongue right / or left chaiselongue wide right / or left

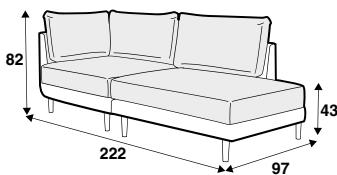

divan right / or left

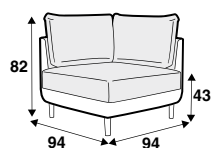

corner 90°

extra dimensions

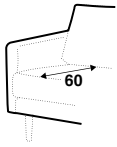

depth of seat

accessories

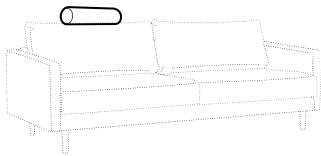

headrest with roll L-60

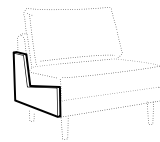
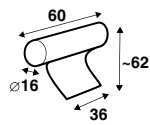

endpart

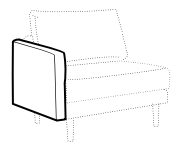

armrest I

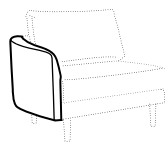
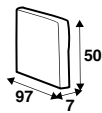

armrest II

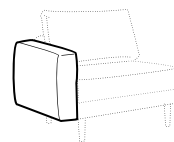
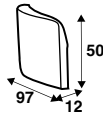

armrest III

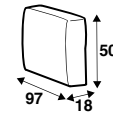

legs

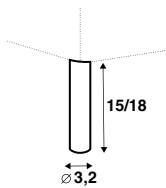

no. 195
metalchrome
and painted black

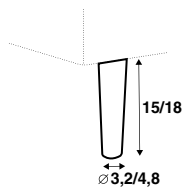

no. 141
wood

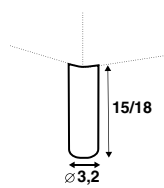

no. 196
wood

nolabel#7

nolabel

INTERIEUR & ONTWERP



nolabel#7

COVERS SPECIAL



fabric



STD standard



FC fixed



modular system

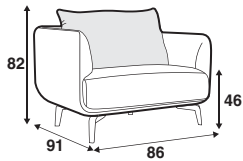

armchair

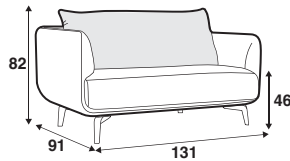

loveseat

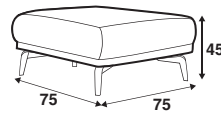

footstool 75x75

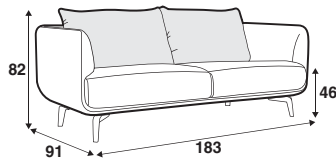

2 seater

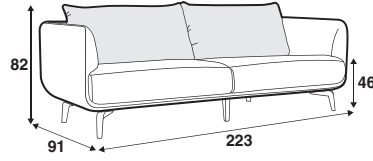

3 seater

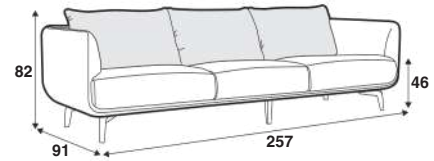

4 seater divided

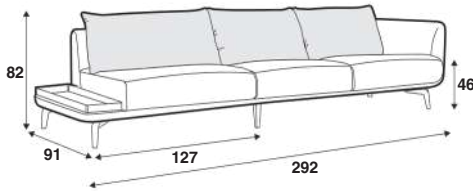

set 1 left / or right

2seaterleft / orleft+bench with tray left / or right

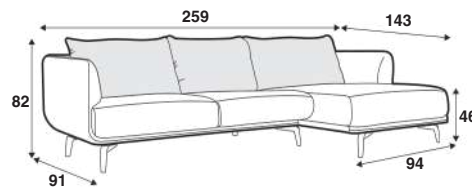

set 2 right / or left

2seaterleft / orright+chaiselongue right / or left

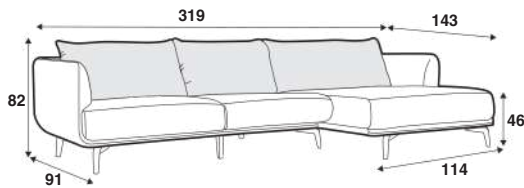

set 3 right / or left

3seaterleft / orright+chaiselongue wide right / or left

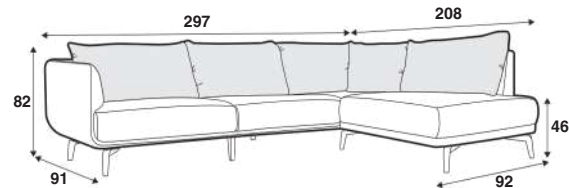

set 4 right / or left

3seaterleft / orright+divan right / or left



set 5 right / or left

3seaterleft / orright+corner 90° + 2 seater right / or left

modular system

corner 90°

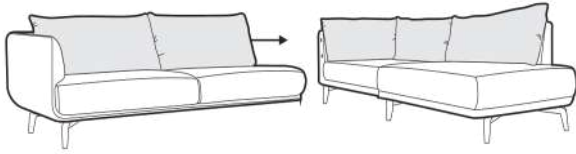

elements of the modular system

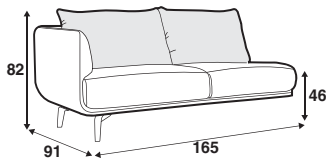

2 seater left / or right

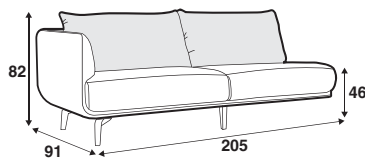

3 seater left / or right

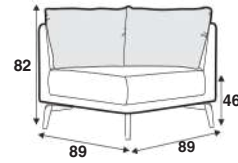

corner 90°

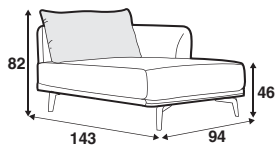

chaiselongue right / or left

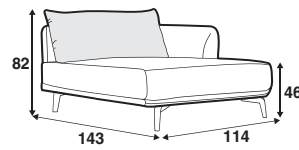

chaiselongue wide right / or left

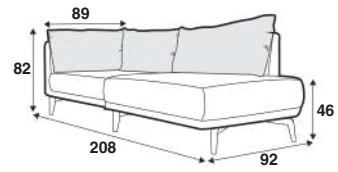

divan right / or left

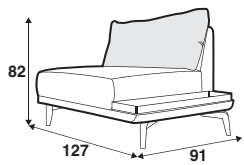

bench with tray right / or left

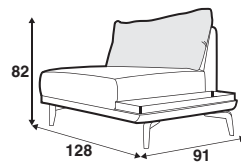

bench freestanding with tray right / or left

extra dimensions

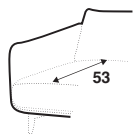

depth of seat

profile

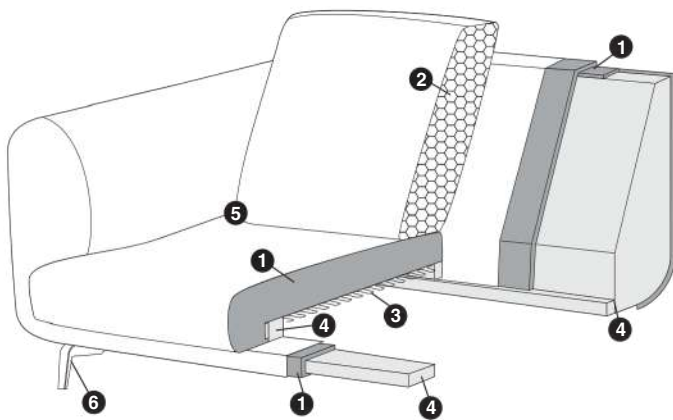

standard

1. polyurethane foam / high resilient polyurethane foam
2. silicone balls
3. springs
4. solid wood and wood based elements
5. fabric
6. solid wood/metal legs



nolabel#11

nolabel

INTERIEUR & ONTWERP



nolabel#11

UPHOLSTERY



fabric

COMFORTS



standard

COVERS



fixed

SPECIAL



modular system

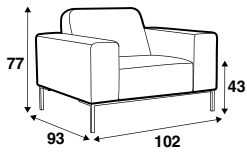

armchair

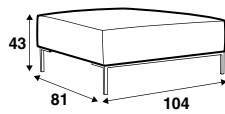

footstool 104x81

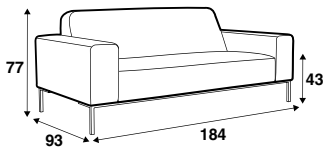

2 seater

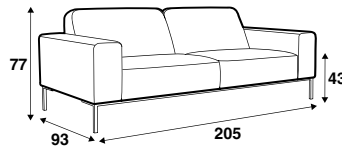

3 seater

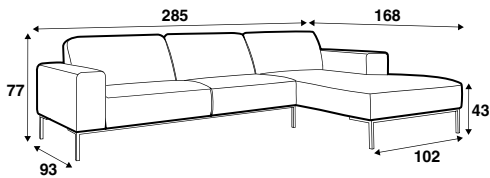

set 1 right / or left
3seaterleft / orright+chaiselongue right / or left

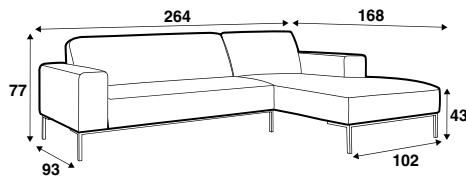

set 2 right / or left
2seaterleft / orright+chaiselongue right / or left

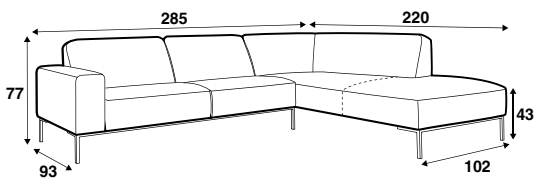

set 3 right / or left
3seaterleft / orright+divan right / or left

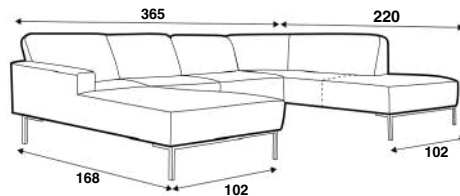

set 4 right / or left
chaiselongue left / or right + 3 seater without armrests + divan right / or left

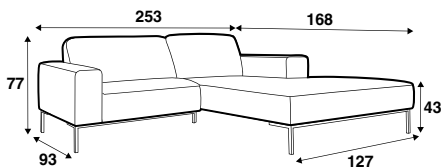

set 5 right / or left
armchairwide left / or right + chaiselongue wide right / or left

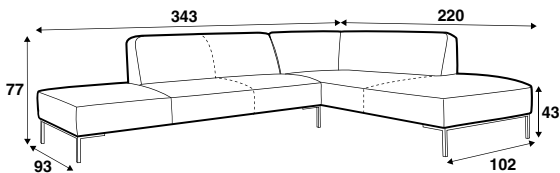

set 6 right / or left
benchleft / orright+divan right / or left

modular system

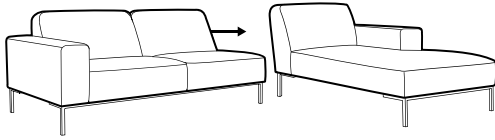

elements of the modular system

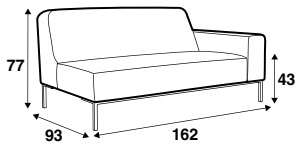

2 seater right / or left

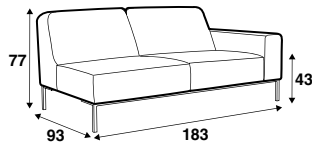

3 seater right / or left

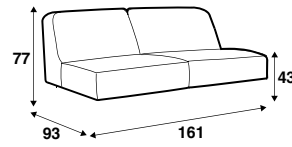

**3 seater
without armrests**

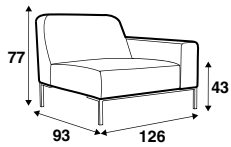

**armchair wide
right / or left**

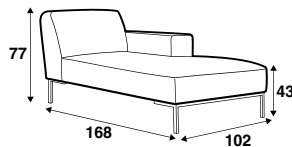

chaiselongue right / or left

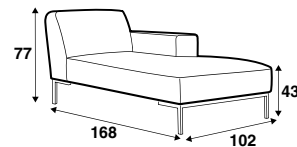

**chaiselongue right / or left
freestanding**

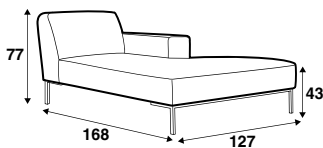

**chaiselongue wide
right / or left**

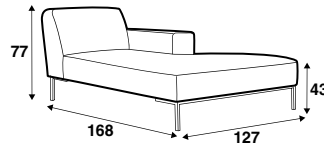

**chaiselongue wide
right / or left freestanding**

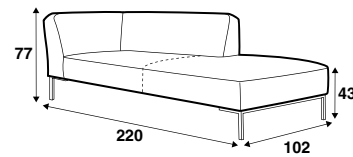

divan right / or left

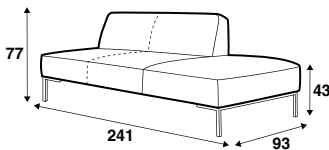

bench right / or left
Only with leg no. 146 H-190

extra dimensions

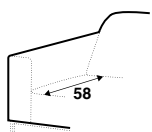

depth of seat

legs

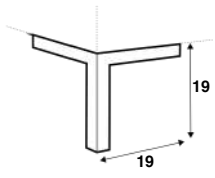

no. 146
metal chrome,
painted black
front and back

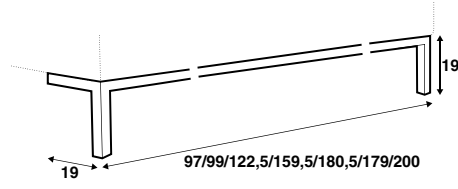

no. 146A
metal chrome,
painted black
only front



profile

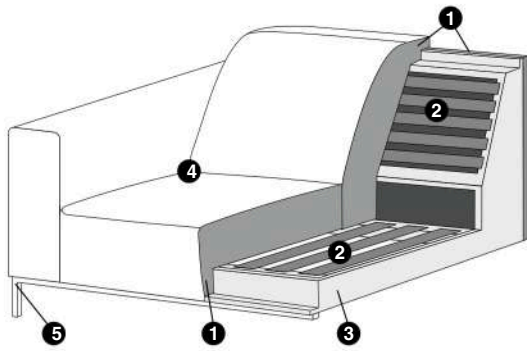

standard

1. polyurethane foam/ high resilient polyurethane foam
2. upholstery belts
3. FSC® certified solid wood and wood based elements
4. fabric
5. metal legs





nolabel interieur & ontwerp
minckelersstraat 10
6211GX maastricht